

RAV-SM564ATP-E Outdoor Unit

- R22 & R407C replacement technology
- Wide operating range (Cooling mode -15°C to $+46^{\circ}\text{C}$)
- Auto diagnostic function
- Flexible, can be utilised for single, twin, triple indoor applications
- Compact size

Model Reference	RAV-SM564ATP-E	
Nominal Cooling	(kW)	5.0
Nominal Heating	(kW)	5.3
Air Flow Standard	(m ³ /h)	2,400
Air Flow Standard	(l/s)	667
Sound Power- Cool / Heat	(dB(A))	63-65
Sound Pressure- Cool/Heat	(dB(A))	46-48
Dimensions (HxWxD)	(mm)	550 x 780 x 290
Unit Weight	(kg)	40
Power Supply—Outdoor	(V-ph-Hz)	220/240-1- 50/60
Interconnecting Cable	3 core plus earth	
Suggested Fuse Size (SM)	(A)	10
Max. Operating current (Cooling)	(A)	7.9
Operating range, Cooling	($^{\circ}\text{C}$)	-15 / +46
Operating range, Heating	($^{\circ}\text{C}$)	-15 / +15
Pipe Sizes (Liquid / Suction)	(Inch)	1/4—1/2
Pipe length, Min—Max	(m)	5—30
Maximum height difference	(m)	30
Pipe length pre-charge	(m)	20
Additional R410A	(g/m)	20

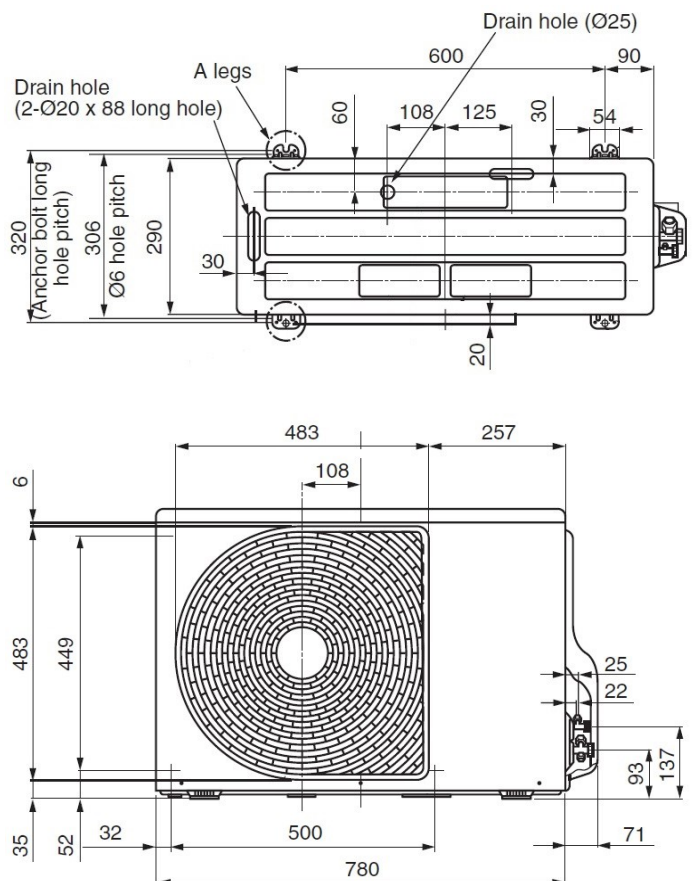

Cool Designs Ltd

Raising the Standards in Air Conditioning Distribution

www.cooldesignsltd.co.uk



All UK duties are based on Cooling Indoor air temperature 22°C DB/ 16°C WB Outdoor air temperature 28°C DB 50% RH, high fan speed, 5m pipe run.
Heating Indoor air temperature 21°C DB Outdoor air temperature -4°C DB 100% RH, high fan speed, 5m pipe run. Values are based on the maximum compressor output.
Data obtained from Toshiba Air Conditioning Web Data July 2013.